



OpenStack Summit

International Convention Centre Sydney

Sydney, Australia | November 6-8, 2017

Sponsor Manual

Table of Contents

| | |
|--|--------------|
| Deadlines at a Glance | Page 2 |
| General Summit Information | Page 4 |
| Summit Schedule | Page 5 |
| Registering for the Summit | Page 6 |
| Booth Staff Credential FAQ | Page 7 |
| Sponsor Services | Page 8 |
| Headline Booth Sponsor Details | Page 9 |
| Premier Booth Sponsor Details | Page 10 |
| Spotlight Booth Sponsor Details | Page 11 |
| Event & Startup Booth Sponsor Details | Page 12 |
| Booth Backdrop Artwork Guidelines | Page 14 - 16 |
| Summit Rules & Restrictions | Page 17 - 19 |
| Chalkboard Guidelines | Page 20 |
| Catering in Sponsor Booth | Page 21 |
| Shipping Information | Page 22 - 23 |
| Headline Keynote & Premier Session Details | Page 24 |
| Marketing Deliverables | Page 25 |
| Add-on Sponsorship Deliverables | Page 26 |
| Sponsor Meeting Rooms | Page 27 |
| Sponsor Contacts | Page 28 |

Deadlines at a Glance

All Sponsors: All deadlines listed are 11:59pm PT (equivalent to 6:59 am UTC on the following date)

- Friday, September 15 First Registration Deadline – prices increase on September 16
- Friday, September 29 Deadline to request use of the OpenStack logo or watermark in any form (see page 17)
- Monday, October 9 Deadline to confirm Marketplace Mixer participation
- Monday, October 9 EARLY BIRD pricing deadline for AV, Electrical, Furniture, Labor, Lead Retrieval, Networking
- Monday, October 9 Networking & Electrical booth layout due to jacki@fntech.com
- Monday, October 9 EAC Form (if applicable)
- Monday, October 9 Last day to upload Company logo in both vector and jpeg formats for Summit signage to FNTECH Sponsor Portal (click on the “Media” tab)

- Wednesday, October 11 Second Registration Deadline - prices increase on October 12
- Monday, October 16 Shipments can be received at the Advance Warehouse
- Monday, October 16 Catering orders for booths and meeting room orders due
- Monday, October 16 STANDARD pricing deadline for AV, Electrical, Furniture, Labor, Lead Retrieval, Networking
- Wednesday, October 25 FINAL DEADLINE to order Sponsor Services before the Summit
- Friday, October 27 Acknowledgement of Inward/Outward Handling Charges form due
- Friday, October 27 Booth staff names to be entered in the Sponsor Services portal
- Friday, October 27 Final Registration Deadline - Last Day to use sponsorship codes on Eventbrite
- Tuesday, October 31 Last day shipments can be received at Advance Warehouse

NEW! Download deadlines directly to your Calendar via the FNTECH Sponsor Services Portal – click on the “Show Deliverables” tab and select the option to download.

Sponsorship Level Deadlines at a Glance

Headline Sponsors Only:

- Wednesday, October 4 75% of Keynote content/presentation due for OpenStack Foundation review
- Monday, October 16 60-second pre-recorded video/commercial (to be played on monitors around the Summit)
- Monday, October 16 100-word paragraph for inclusion in a Summit preview email sent to all registered attendees
- Monday, October 16 Keynote final content

Headline & Premier Sponsors:

- Monday, October 16 Housekeeping slide (16:9 ratio: jpeg, Keynote or PowerPoint format)

Headline, Premier & Spotlight Sponsors:

- Tuesday, October 3 Custom booth back wall artwork file due. Upload artwork to “Media” tab: <https://sponsorservices.fntech.com>

Premier Sponsors:

- Monday, October 16 40-minute Sponsor Session details

Add-on Sponsorships:

- Monday, October 9 Sponsor Lounge concept
- Monday, October 16 Demo Theater details
- Monday, October 16 Full-day and Half-day track details

General Summit Information

Venue:

International Convention Centre Sydney (ICC Sydney)
14 Darling Dr.
Sydney NSW 2009, Australia

Registration:

<https://www.openstacksummit2017sydney.eventbrite.com>

Visa Information: Please note that ALL non-Australian residents will need a visa to travel to Australia

<https://www.openstack.org/summit/sydney-2017/travel/#visa>

Hotels:

<https://www.openstack.org/summit/sydney-2017/travel/#hotels>

Sponsor Related Deadlines:

<https://docs.google.com/document/d/1PkLK6Ty3ov5uvqleCrCYeSanfigLKKwhc3eGIWSsWI0/edit?usp=sharing>

For more information, visit:

<https://www.openstack.org/summit/sydney-2017/>

Summit Schedule*

Summit Schedule*:

| | |
|--------------------------------------|------------------|
| Monday, November 6 | 10:00am – 5:50pm |
| <i>Marketplace Mixer</i> | 5:50pm – 7:30pm |
| Tuesday, November 7 | 9:00am – 6:30pm |
| Wednesday, November 8 | 9:00am – 6:00pm |
| <i>Stack City Party at Luna Park</i> | 6:30pm – 9:00pm |

Registration/Check-in Hours*:

| | |
|--|-----------------|
| Sunday, November 5 | |
| <i>Headline, Premier & Spotlight</i> | 8:00am – 7:00pm |
| <i>All Sponsors</i> | 1:00pm – 7:00pm |
| <i>Attendees</i> | 3:00pm – 7:00pm |
| Monday, November 6 | 7:00am – 6:30pm |
| Tuesday, November 7 | 8:00am – 6:30pm |
| Wednesday, November 8 | 8:30am – 6:00pm |

*May change depending on final show schedule.

**Sponsors must be checked in Monday, November 6 by 9am.
Unattended booths will have boxes removed from the floor by 10am on Monday.

Marketplace Installation**:

Sunday, November 5

| | |
|--|-----------------|
| <i>Headline, Premier & Spotlight</i> | 8:00am - 7:00pm |
| <i>Event & Start-Up</i> | 1:00pm – 7:00pm |

Marketplace Hours*:

Monday, November 6

| | |
|---|------------------|
| <i>Marketplace Mixer</i> | 12:00pm – 4:30pm |
| | 5:50pm – 7:30pm |
| <i>Marketplace will be closed to attendees from 4:30 to 5:50pm for mixer set-up. Please have your booth staffed by 5:30pm for the start of the mixer.</i> | |

Tuesday, November 7

| | |
|----------------------|-----------------|
| <i>Melbourne Cup</i> | 9:00am – 5:50pm |
| | 2:30pm – 3:20pm |

Wednesday, November 8

| | |
|--|-----------------|
| | 9:00am – 2:00pm |
|--|-----------------|

Marketplace Dismantle:

Wednesday, November 7

| | |
|--|-----------------|
| | 2:00pm – 7:00pm |
|--|-----------------|

Sponsor Meeting Room:

| | |
|----------------------------------|-------------------|
| Installation: Sunday, November 5 | 1:00pm – 7:00pm |
| Dismantle: Wednesday, November 8 | Cleared by 6:30pm |

Sponsor Lounge/Activity Station:

| | |
|----------------------------------|-------------------|
| Installation: Sunday, November 5 | 1:00pm – 7:00pm |
| Dismantle: Wednesday, November 8 | Cleared by 6:30pm |

Registering for the Summit

All attendees (including booth staff) must register for the Summit on Eventbrite:

<https://www.openstacksummit2017sydney.eventbrite.com>

To Register using your Sponsorship passes

On the Eventbrite registration page, click on “Tickets” and enter your promotional code BEFORE you check out (see image below). If you are using a complimentary code and are asked to enter credit card information, the code was not entered properly.

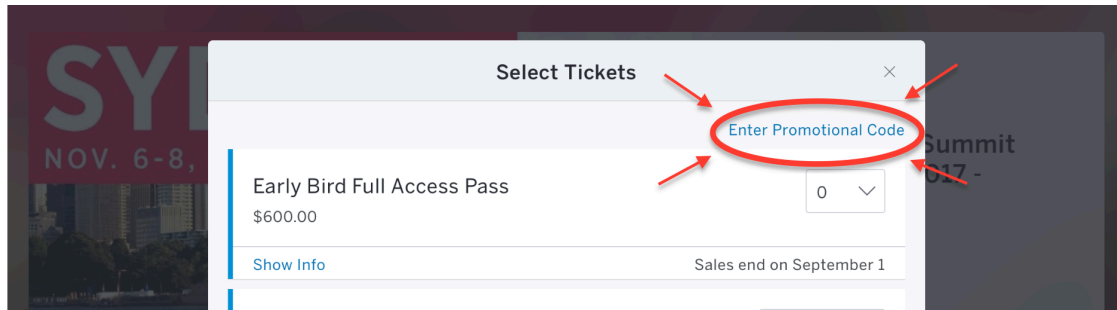

Registering booth staff for the Summit is a 2-step process:

1. Register your staff via Eventbrite: <https://www.openstacksummit2017sydney.eventbrite.com>
2. Add staff names to the FNTECH Sponsor Services Portal under the “Booth Staff Credential” tab

Registration Codes by Sponsorship Level

Headline Sponsor: (18) Full Access, (1) Unlimited 10% discount code, (12) Booth Staff Credentials

Premier Sponsor: (14) Full Access, (1) Unlimited 10% discount code, (10) Booth Staff Credentials

Spotlight Sponsor: (10) Full Access, (1) Unlimited 10% discount code, (8) Booth Staff Credentials

Event & Startup Table Sponsor: (6) Full Access, (1) Unlimited 10% discount code, (4) Booth Staff Credentials

OpenStack will email registration codes to you. You can also find them on the FNTECH Sponsor Services portal “Registration Code” tab.

Deadline to use Sponsorship Codes in Eventbrite: Friday, October 27, 2017

Booth Staff Credential FAQ

How many Booth Staff Credentials do I receive?

See “Registration Codes by Sponsorship Level” on previous page.

What is a Booth Staff Credential?

- The Booth Staff Credential is an added designation on the Summit Badge that will grant staff access to the Marketplace during Sponsor installation/dismantle hours, daily before/after the Marketplace is open to attendees, and during the afternoon setup time before the Marketplace Mixer.
- Staff access is 8:30am on show days and 30 minutes post Marketplace closing.
- For safety and security reasons, only staff with a designated Booth Staff Credential and valid Summit Badge will be able to access the Marketplace before and after Summit hours.

NOTE: All Sponsors must wear their Summit badge while setting up and tearing down. For safety reasons, Security will ask anyone not wearing a valid Summit badge to leave the Marketplace immediately.

Who should be assigned Booth Staff Credentials?

- Booth Staff Credentials should be assigned to those who will set up, dismantle or work first or last shift of your exhibitor booth.
- Staff that are responsible for setting up sponsor meeting rooms and lounges should be assigned booth staff credentials.
- Staff will be able to pick up their Summit badge with the added credential during registration hours and access the Marketplace for setup.

Who should NOT be assigned Booth Staff Credentials?

- Booth staff who are not a part of booth setup UNLESS there are extra credentials leftover after all setup staff are entered.
- Daily booth staff (those working in the booth) do not need the added credential UNLESS they need to enter the Marketplace before/after Summit hours.

Booth Staff Credential DOES NOT:

- Grant anyone access to the Summit. All staff must also be registered via Eventbrite. The Booth Staff Credential must be used in conjunction with a valid Summit pass.

What is an Exhibitor Appointed Contractors (EAC)? Do they require a Booth Staff Credential?

- Exhibitor Appointed Contractors that are hired by you for set-up and dismantle do not need a Booth Staff Credential. You must submit the proper paperwork in order for EACs to gain access to the show floor for set-up and dismantle only. Refer to the Shipping Manual for details.

Deadline: Staff names must be entered in the Sponsor Services portal no later than **Friday, October 27.**

Additional Booth staff credentials may be purchased for \$50 each through the Sponsor Services portal.

Sponsor Services

The FNTECH Sponsor Services portal is your online resource for:

- Ordering additional services for your presence at the OpenStack Summit
- Accessing sponsor-specific documents
- Uploading logos and artwork

<https://sponsorservices.fntech.com>

You will receive login credentials for the site via email the week of July 24 or within one week post booth selection. Please contact Jacki Krawiecki, jacki@fntech.com if you do not receive them. If you have used the portal before, the Sydney Summit will be added to your existing account.

Sponsor Services Order Deadlines:

- Early Bird Pricing Deadline: Monday, October 9 at 11:59pm PST
- Standard Pricing Deadline: Monday, October 16 at 11:59pm PST
- Sponsor Services Site will be closed: Wednesday, October 25 at 11:59pm PST

All pre-Summit orders must be received by: Wednesday, October 25 at 11:59pm PST. Any orders requested after this date will be processed onsite based on availability.

Cancellation Policy:

If the equipment/service order is cancelled by the Sponsor for any reason 21 days or more before the scheduled event (regardless of when the order was placed), a full refund will be issued by FNTECH. If the equipment/service order is cancelled for any reason by the Sponsor within 21 days of the scheduled event, the full balance must be paid to FNTECH immediately with no obligation by FNTECH. Cancellation of any type must be in writing.

Headline Sponsor Booth Details

Dimensions: 7.5m W x 3m D (For U.S.: approximately 24' 7" W x 9' 10" D)

Booth Includes:

- Back wall customized with company logo or custom artwork
- 43" HD monitor with stand
- 1.8m (5.9') black draped table
- (2) chairs
- Black carpet
- Wireless Internet access
- Waste bin
- 15amps of electricity*
- (1) power strip
- Double-sided chalkboard**

*Power included in package can not be split.

Power will be laid back center of booth unless otherwise specified on booth layout.

** To be placed by show management

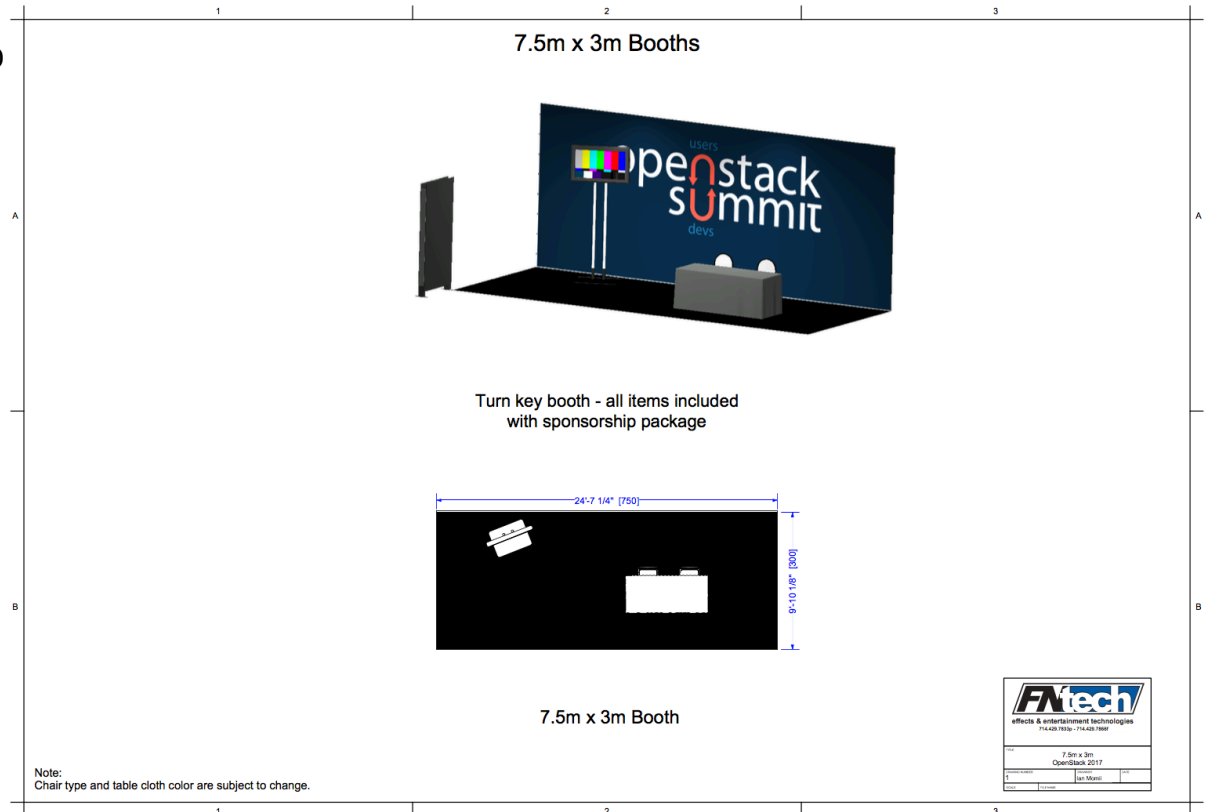

Should you require any additional services, such as audiovisual equipment, electricity, security, custom signage, or Internet connectivity, please work directly with your Sponsor Manager, Jacki Krawiecki. All orders must be placed through the FNTECH Sponsor Portal. Your company will be billed directly.

Premier Sponsor Booth Details

Dimensions: 4.5m W x 3m D (For U.S.: approximately 14' 9"W x 9' 10"D)

Booth Includes:

- Back wall customized with company logo or custom artwork
- 43" HD monitor with stand
- 1.8m (5.9') black draped table
- (2) chairs
- Black carpet
- Wireless Internet access
- Waste bin
- 10amps of electricity*
- (1) power strip
- Single-sided chalkboard**

*Power included in package can not be split.
Power will be laid back center of booth unless otherwise specified on booth layout.

** To be placed by show management

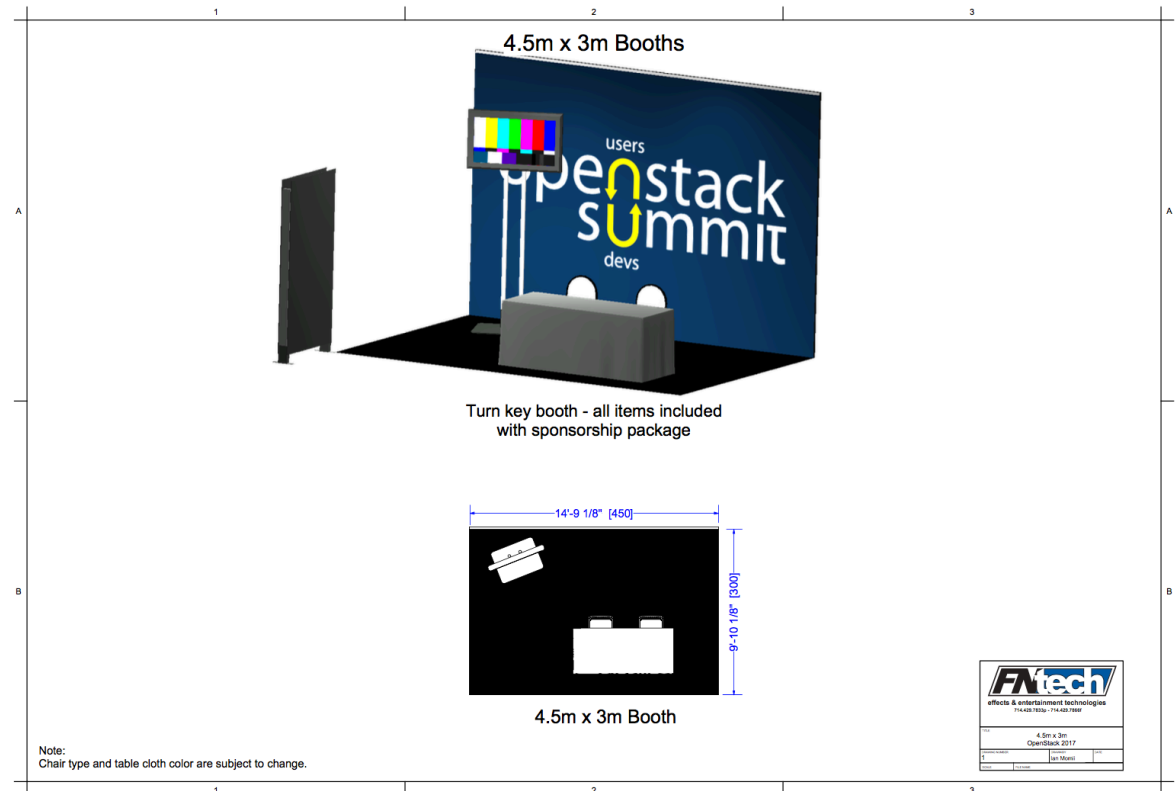

Should you require any additional services, such as audiovisual equipment, electricity, security, custom signage, or Internet connectivity, please work directly with your Sponsor Manager, Jacki Krawiecki. All orders must be placed through the FNTECH Sponsor Portal. Your company will be billed directly.

Spotlight Sponsor Booth Details

Dimensions: 3m W x 3m D (For U.S.: approximately 9' 10"W x 9' 10" D)

Booth Includes:

- Back wall customized with company logo or custom artwork
- 43" HD monitor with stand
- 1.8m (5.9') black draped table
- (2) chairs
- Black carpet
- Wireless Internet access
- Waste bin
- 10amps of electricity*
- (1) power strip
- Single-sided chalkboard**

*Power included in package can not be split.

Power will be laid back center of booth unless otherwise specified on booth layout.

** To be placed by show management

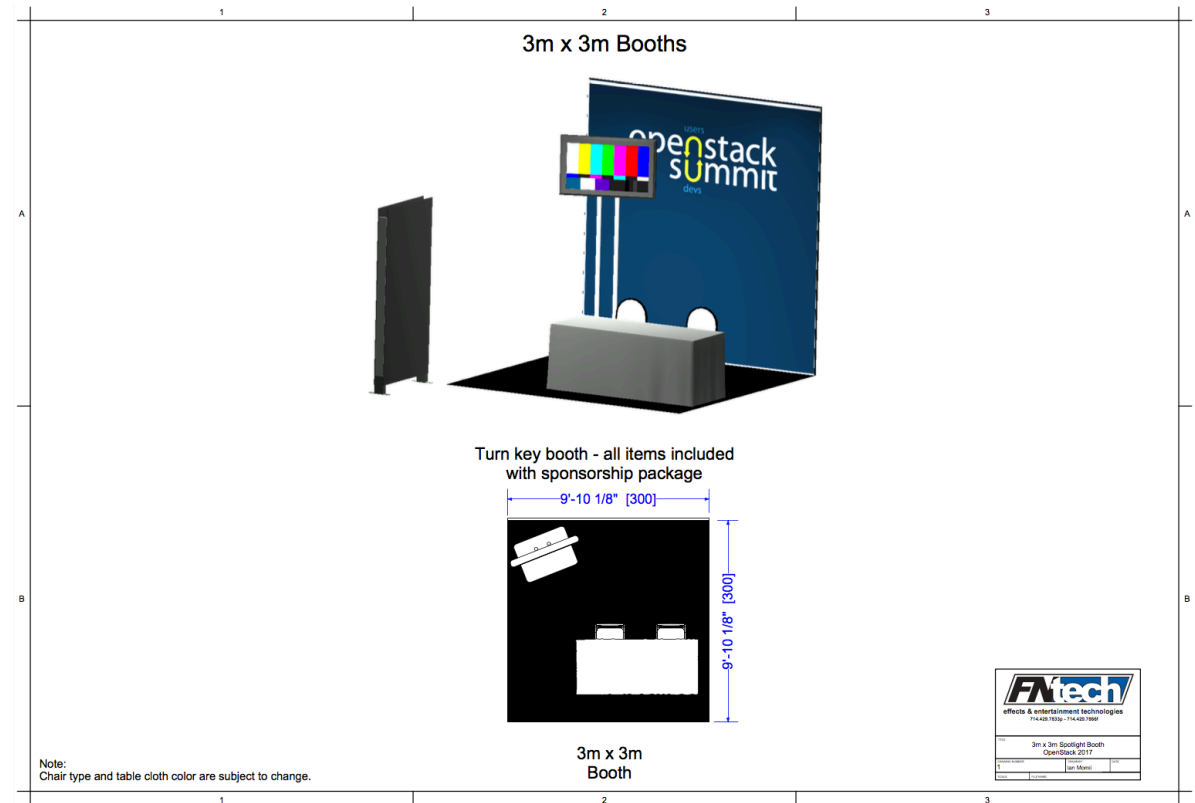

Should you require any additional services, such as audiovisual equipment, electricity, security, custom signage, or Internet connectivity, please work directly with your Sponsor Manager, Jacki Krawiecki. All orders must be placed through the FNTECH Sponsor Portal. Your company will be billed directly.

Event & Startup Sponsor Table Details

Dimensions: 3m W x 2.5m D (For U.S.: approximately 14' 9"W x 8' 2"D)

Table Booth Includes:

- 1.8m (5.9') black draped table
- Wireless Internet access
- (1) power strip
- 4amps of electricity *
- (2) chairs
- Waste bin
- Black carpet
- Single-sided chalkboard**

*Power included in package can not be split.
Power will be laid underneath your table unless otherwise specified on booth layout.

** To be placed by show management

Event / Startup Sponsor
Table and Chairs Only

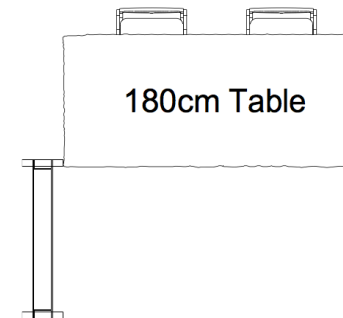
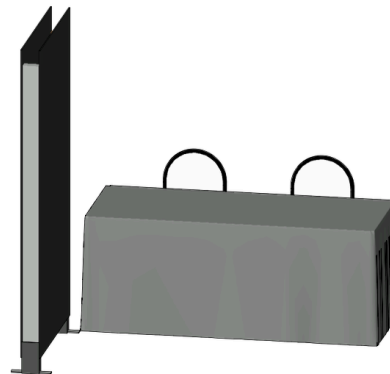

Note:
Chair type and table cloth color are subject to change.



Should you require any additional services, such as audiovisual equipment, electricity, security, custom signage, or Internet connectivity, please work directly with your Sponsor Manager, Jacki Krawiecki. All orders must be placed through the FNTECH Sponsor Portal. Your company will be billed directly.

Booth Renderings

All Booths (Optional Side Graphics Not Shown)

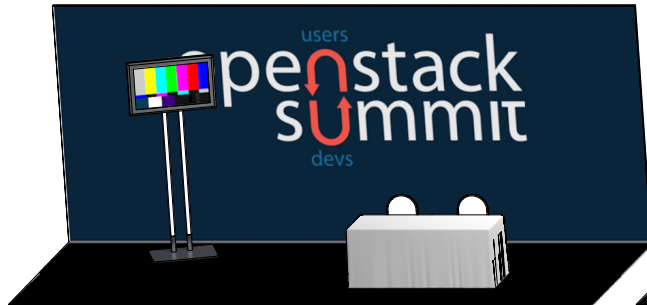

7.5m x 3m Booth

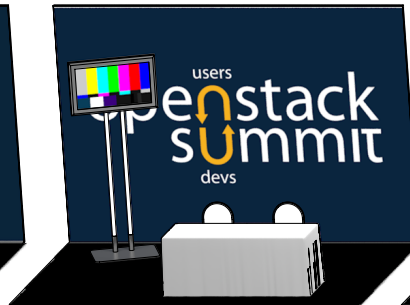

4.5m x 3m Booth

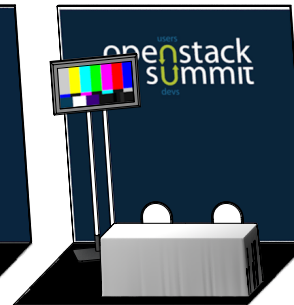

3m x 3m Booth



Table Sponsor

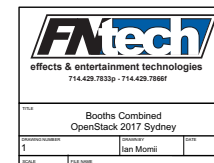
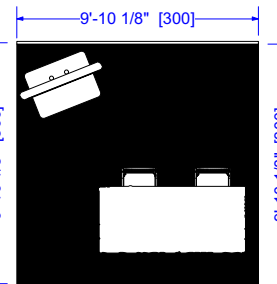
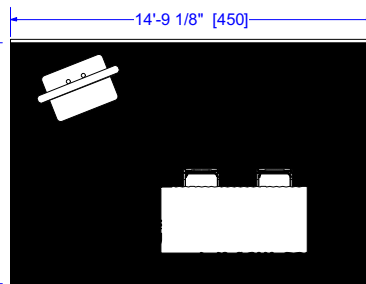
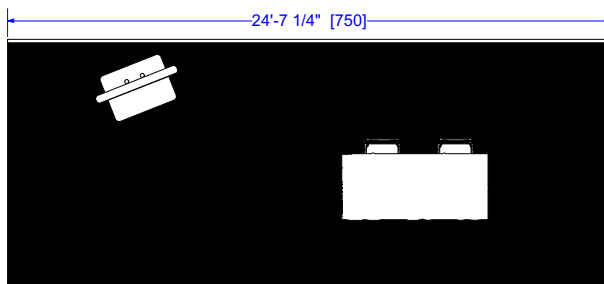

Note:
Chair type and table cloth color are subject to change.

Booth Backdrop Artwork Guidelines

*****IMPORTANT: Artwork requirements have changed for Sydney – please review artwork guidelines carefully (continues on following page) and note spec changes on page 16*****

File Requirements:

- Finalized artwork MUST be received in high resolution PDF or EPS format.
- Bleed: Include a 10mm bleed.
- Leave a 50mm SAFE trim margin for all text and essential graphics.
- All text (including logos) MUST be converted to outlines.
- Embed all placed images, scans and illustrations.
- Set files to CMYK color space.

Resolution:

- Please scale your print ready artwork to 25% of final size with a resolution of 300dpi.
- Alternately print ready artwork supplied at 100% final size with a resolution of 150 dpi is also acceptable.
- Please limit your file size to no more than 500MB per file. Time involved to setup and process larger files may incur additional charges.

Booth Backdrop Artwork Guidelines (continued)

Color Requirements:

- Supply Pantone colors for accurate color representation (stating solid coated reference numbers).
- Please supply a hard copy for proofing if available.
- All photographic images need to be supplied as CMYK. For images that require Pantone colors please supply a layered PSD file.
- Please note, all due care will be taken to match Pantone colors. Please be aware some colors are outside of the gamut of conventional CMYK printers.
- For optimal results when printing black please supply any black in your files as C60%, M60%, Y60%, K100%.

Transparency and Gradient Requirements:

- Please flatten and rasterize all transparent objects in your print ready artwork.
- RASTERIZE vector gradients and ADD 4% NOISE/GRAIN.
- The "lightest" value must be higher than zero (at least a 5% color).
- Use a blend that changes at least 50% between two or more process-color components.
- Make dark blends short. Banding is most likely to occur between very dark colors and white.
- If you create a gradient between two or more spot colors, assign different screen angles to the spot colors when you create color separations.

Submitted files that do not follow these guidelines may incur additional charges due to longer processing time

Booth Backdrop Artwork Deadline

Custom artwork for your back wall is due no later than Tuesday, October 3.

- If artwork is not received by Wednesday, October 4, your logo will be printed on the backdrop.
- Late fees will apply for artwork submitted after the deadline.
- Upload artwork directly to the “Media Upload” tab of the Sponsor Services portal.

Booth Backdrop Specs by Sponsor Level

Headline Sponsors

- Specs: 7435mm W x 2974mm H
- For U.S.: approximately 24.39' W x 9.76' H

Premier Plus Sponsors (add-on "5ft" – 1.485m)

- Specs: 5950mm W x 2974mm H
- For U.S.: approximately 19.52' W x 9.76' H

Premier Sponsors (and Spotlight Plus Sponsors)

- Specs: 4465mm W x 2974mm H
- For U.S.: approximately 14.65' W x 9.76' H

Spotlight Sponsors

- Specs: 2971mm W x 2974mm H
- For U.S.: approximately 9.75' W x 9.76' H

NOTE: Add 10mm bleed to all sides of artwork files. Please scale your print ready artwork to 25% of final size with a resolution of 300dpi. Alternately, print ready artwork supplied at 100% final size with a resolution of 150 dpi is also acceptable. Files that exceed 500MB may incur an additional fee. See page 14-15 for more detailed file guidelines.

Summit Rules & Restrictions

All Sponsors

- Sponsors are not permitted to ship in their own custom booth backdrop or walls. You are required to use the turnkey booth that's provided.
- ONLY the official Lanyard Sponsor is permitted to distribute lanyards to Summit attendees.
- Booth staff meetings are not permitted in the Marketplace during set-up hours unless all staff have the proper credentials.
- Projected sound is not permitted in the booths - no microphones/speakers/amplifiers of any sort.
- All sponsorships include a chalkboard. The chalkboard cannot be moved, removed, or upgraded. Your sponsor logo will be displayed at the top.
- All signage, furniture and equipment must be kept inside Sponsor allotted booth and contracted space. No exceptions.
- Marketing materials of any kind may only be distributed within your Sponsored contracted space. Distributing flyers in hallways is not permitted.
- Uses of the OpenStack logo or watermark in any form, including booth signage and giveaway items, must be approved via logo@openstack.org. Deadline: Friday, September 29
- OpenStack Summit Code of Conduct: <https://www.openstack.org/summit/sydney-2017/code-of-conduct>

Additional rules and restrictions based on sponsorship level can be found on page 17 & 18.

Additional Summit Rules & Restrictions

Headline, Premier and Spotlight Sponsorship levels:

- Your booth is turnkey and does not require shipment or setup of a booth property – please see booth renderings on pages 9, 10, and 11.
- Custom booth properties, such as demo counters, are permitted, however, counters may not be more than 4' tall (1.22 m).
- Booth must be open on 3 sides.

NOT PERMITTED:

Demo counters that create a visual barrier.



PERMITTED:

Demo counters that do not create a visual barrier.



Additional Summit Rules & Restrictions

Event & Start up Sponsorship levels:

- 6ft table is cannot be moved, removed, or upgraded.
- 8'x8'(2.5m x 2.5m) or 10'x10' (3.1m x 3.1) pop-up booths are not permitted on the show floor.
- Total pop-up banner footprint may not be larger than 6.5'W x 8'H (2m x 2.5m).
- Full racks, or other equipment of similar size, are not permitted.

NOT PERMITTED:

Pop-up Booths, Full Racks or equipment equal in size.



PERMITTED:

Pop-up banners or half racks.

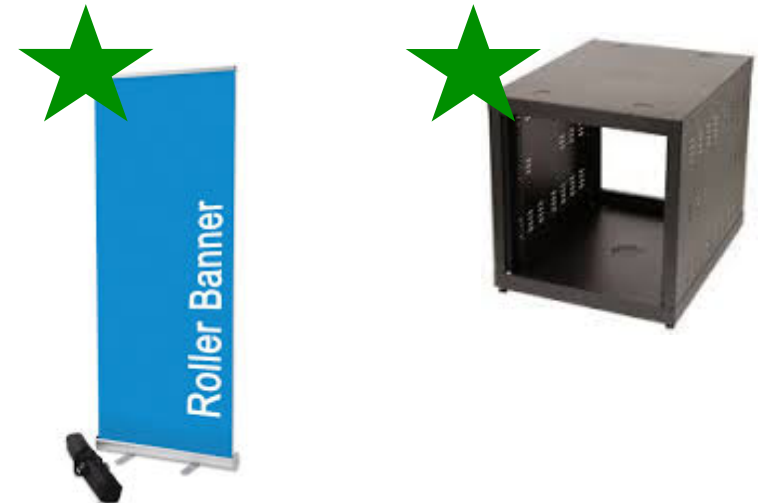

Chalkboard Guidelines

All Sponsors:

All Sponsorships include a single sided chalkboard that will be placed by show management. Your company logo will be placed at the top of the chalkboard: approximately 72.5cm W x 36.2cm H (28.5" W x 14.25" H). Sponsors are encouraged to customize their chalkboard under the following guidelines:

- Chalk or chalkboard pens are the only PERMITTED tool that can be used to draw/write on the chalkboard.
- Permanent marker, such as Sharpies, should **NOT** be used at any time.
- Decals/Stickers are permitted but must be produced in the following materials: SolvoPrint Easy Dot (Matte or Clear), or PhotoFAB Ultra, or 3M Controltac removable vinyl.
- Decals cannot exceed 140cm H x 71cm W (approximately 55" h x 28" w.)
- If damage is caused to the chalkboard there will be a \$500 charge to the sponsor.

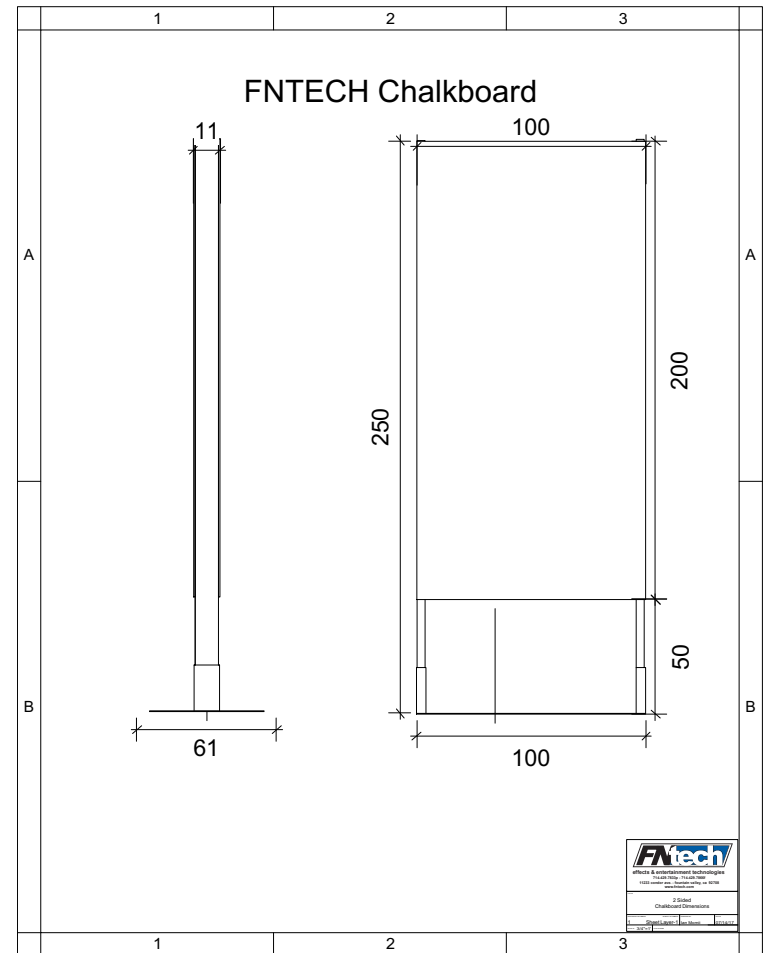

Please note: Chalkboard dimensions shown in cm.
Final chalkboard dimensions/design subject to change.

Catering in Sponsor Booth

Catering is permitted in Sponsor booths under the following conditions:

- Sponsor must receive OpenStack Foundation approval prior to placing catering order for booth.
- Coffee service or coffee specialty drinks are NOT permitted to be served in sponsor booths.
- Alcohol may be served in Sponsor booth starting with the daily afternoon break.
- Catering must be kept and distributed from within your booth space.
- All food and beverages must be provided by the Convention Centre catering services; no outside food or beverages will be permitted.
- Please make your request with the Summit catering manager, Sarah Krawiecki (sarah@fntech.com), no later than Monday, October 16.
- Once you receive approval, you will be connected with the International Convention Centre (ICC) Sydney catering department. Ordering and invoicing will be direct between Sponsor and the ICC.

Shipping Information

Shipping Manual

Please thoroughly read the Sydney shipping manual found on the FNTECH Sponsor Services Portal. This manual details shipping instructions, deadlines, required documentation and handling charges.

Acknowledgement of Inward/Outward Handling Charges

Please read, sign and return the Acknowledgement of Handling Charges (found on the portal) to shipping@fntech.com.

Deadline: Tuesday, October 31.

Advance Warehouse

All booth material MUST be received at the Advance Warehouse NO LATER THAN Tuesday, October 31. Items can be received between Monday, October 16 and Tuesday, October 31. Warehouse hours are 8:30am -4:00pm (8:30 – 16:00), Monday-Friday. Please use the shipping label (found on the next page) for all OpenStack Summit Sydney materials being shipped to the Advance Warehouse. Please fill in all areas shown in GREEN with your information. Please send a pre-alert to shipping@fntech.com for all items being sent to the advance warehouse.

Direct to Show

By Appointment ONLY. Full and Semi Trailer Loads ONLY.

NO FEDEX or UPS deliveries will be received at the venue.

Please send Direct to Show appointment requests to shipping@fntech.com.

Advance Warehouse Shipping Label

Please note that all packages must arrive with the following label. Please fill in all areas shown in **GREEN** below with requested information. If packages arrive improperly labeled, we cannot guarantee delivery. A 15% service charge will be applied to final invoices of packages that are received without proper documentation or case markings.

NAME OF EXHIBITOR/SPONSOR: _____

Booth/Stand Number/Location: _____

Sponsor Contact: _____

Contact Phone Number: _____

**OpenStack Summit 2017
C/O Agility Fairs & Events
10 Marigold Place
Milperra, NSW 2214
Australia**

Piece of _____

Headline Sponsor Keynote Information:

Keynote Details:

- All Content (slides & video) must be shared with the OpenStack Foundation for review. Failure to submit Keynote content could result in disqualification.
- All Keynote speakers agree to attend mandatory on-site rehearsals one day prior to their presentation.
- Sponsors/speakers are responsible for all content.

Keynote Deadlines:

- Notify the keynote producer Tamara Pennington, tamara@fntech.com, about any demos and/or special requirements. Sponsor may be responsible to pay for additional production costs. Deadline: ASAP but not later than Monday, October 23.
- 75% of content and presentation must be sent to OpenStack Foundation for review. Edits may be required. Deadline: Wednesday, October 4.
- All Final Content must be received prior to keynote. Deadline: Monday, October 16.

Premier Sponsor 40 minute Breakout:

Sponsored Session Details:

- 40 minute breakout session details are due Monday, October 16.
- Details to be submitted through a form that will be provided in late August.

Marketing Deliverables

Submit ALL Marketing Deliverables below via the FNTECH Sponsor Services Portal under “Media Upload” <https://sponsorservices.fntech.com>

All Sponsors - Please upload ASAP - Due no later than Monday, October 9:

- Logo in jpeg and vector format for OpenStack Summit Sydney website and signage.
- Company name as you want it to appear on Summit collateral materials.

Headline Sponsors – Deadline Monday, October 16:

- 100-word paragraph for inclusion in a Summit preview email sent to all registered attendees.
- 60-second pre-recorded video/commercial that will be played throughout the Summit on various monitors – no audio.

Headline, Premier & Add-On Sponsors – Deadline Monday, October 16:

- Housekeeping slide to be played in a loop between presentation (16:9 ratio, image may be provided in jpeg format or as a Keynote or PowerPoint slide.)

Marketplace Mixer

All Sponsors:

- All sponsors are encouraged to offer food and beverage items in their booths during the Marketplace Mixer on Monday, November 6 from 5:50 pm to 7:30pm.
- Pricing and food/beverage options will be sent at a later date.
- All food/beverages must be ordered through the official venue catering department. Outside vendors are not permitted.
- Deadline to participate: Monday, October 16.
- Please email Sarah Krawiecki, sarah@fntech.com to confirm participation.

Demo Theater Add-on

Add-on Sponsorship:

Opportunity to purchase a 20-minute presentation in the Demo Theater (promoted in official Summit agenda)

- Presentation title, speaker name and abstract due by Monday, October 16.
- Time slot selection based on time-stamped agreements
- Theater specs will be sent via email from jacki@fntech.com

Sponsor Lounges

Add-on Sponsorship:

- Lounge concepts are due by Monday, October 9.
- Please email details to Jacki, jacki@fntech.com

Full-Day / Half-Day Tracks

Add-on Sponsorship:

- Full-day and Half-Day track details are due Monday, October 16. Details will be submitted via the custom submission tool which will be granted access to late August.

Sponsor Meeting Rooms:

Meeting Rooms include:

- Basic Power: 4amps of power
- (1) power strip on table
- Sponsor wireless internet

Headline Sponsors:

- One meeting room is included with your paid sponsorship.
- Meeting room capacities will vary based on location, but maximum capacity should not exceed 20.
- The standard room set up will consist of a boardroom style table and 8-12 chairs.
- If you require a different layout, please inform Jacki by Monday, October 16. Modifications to room layouts may incur an additional charge.

Add-on Meeting room Sponsorship:

- Meeting rooms are available to purchase on a first come, first served basis. Please contact jacki@fntech.com for more information.
- Meeting room capacities will vary based on location, but maximum capacity should not exceed 20.
- The standard room set up will consist of a boardroom style table and 6-12 chairs.
- If you require a different layout, please inform Jacki by Monday, October 16. Modifications to room layouts may incur an additional charge.

Sponsor Contacts

General Sponsor Inquiries: Jacki Krawiecki, jacki@fntech.com

Sponsor Services: Jacki Krawiecki, jacki@fntech.com

Shipping: Ian Prothero, shipping@fntech.com

Catering Request: Sarah Krawiecki, sarah@fntech.com

Meeting Space Request: Jacki Krawiecki, jacki@fntech.com

Sponsor Lounges & Activity Stations: Jacki Krawiecki, jacki@fntech.com

Paid Sponsored Breakout Sessions: Jacki Krawiecki, jacki@fntech.com

Headline Sponsor Keynote: Tamara Pennington, tamara@fntech.com

Speaker Support: speakersupport@openstack.org

Other Sponsorship Opportunities: summit@openstack.org

Registration Related Questions: summitreg@openstack.org