

openstack®

OpenStack Summit

Vancouver Convention Centre

Vancouver, Canada | May 21 to 24

Sponsor Manual

Table of Contents

General Summit Information	Page 2
Summit Schedule	Page 3
Deadlines at a Glance	Page 4 - 5
Registering for the Summit	Page 6
Booth Staff Credential FAQ	Page 7
FNTECH Sponsor Services	Page 8
Summit Rules & Restrictions	Page 9
Headline Sponsor Booth Details	Page 10 - 12
Premier Sponsor Booth Details	Page 13 -15
Spotlight Sponsor Booth Details	Page 16 - 17
Exhibitor Sponsor Details	Page 18 - 19
Booth Renderings	Page 20
Booth Backdrop Artwork Guidelines	Page 21 - 22
Catering in Booth	Page 23
Shipping Information	Page 24 - 25
Sponsor Speaking Details	Page 26
Marketing Deliverables	Page 27
Add-on Sponsorship Deliverables	Page 28
Meeting Rooms	Page 29
Contacts	Page 30

General Summit Information

Venue:

Vancouver Convention Centre

1055 Canada Pl

Vancouver, BC V6C 0C3 Canada

<https://www.vancouverconventioncentre.com>

Useful Links:

Registration: <https://openstacksummit2018vancouver.eventbrite.com>

Visa Information: <https://www.openstack.org/summit/vancouver-2018/visa-and-travel-support/>

Hotels: <https://www.openstack.org/summit/vancouver-2018/travel/>

Sponsor Related Deadlines:

https://docs.google.com/document/d/1i5iWlpRj0_EMbCV7IZCx6raMrpZkzDTiW8ZdpkHoOA4/edit?usp=sharing

FNTECH Sponsor Services Portal: <https://sponsorservices.fntech.com>

Additional Summit information: <https://www.openstack.org/summit/vancouver-2018/>

Summit Schedule*

Summit Schedule*:

Monday, May 21	9:00am – 6:10pm
Tuesday, May 22	9:00am – 6:10pm
Wednesday, May 23	9:00am – 6:00pm
Thursday, May 24	9:00am – 6:00pm

Registration*:

Sunday, May 20

Sponsors

Headline, Premier, Spotlight 8:00am – 7:00pm

Exhibitor 1:00pm – 7:00pm

Attendees

3:00pm – 7:00pm

Monday, May 21 7:00am – 7:30pm

Tuesday, May 22 8:00am – 6:30pm

Wednesday, May 23 8:30am – 6:30pm

Thursday, May 24 8:30am – 6:00pm

*Schedule may change depending on final show schedule.

**Sponsors must be checked in Sunday, May 20 by 6pm. Unattended booths will have boxes removed from the floor at 6pm.

Marketplace Hours*:

Monday, May 21 10:45am – 7:30pm

Marketplace Mixer 6:00pm – 7:30pm

Marketplace will be closed to attendees from 4:45 to 5:45pm for mixer set-up.

Tuesday, May 22 10:45am – 6:00pm

Wednesday, May 23 9:00am – 6:00pm

Thursday, May 24 9:00am – 1:30pm

Sponsor Installation**:

Sunday, May 20

Headline, Premier & Spotlight 8:00am – 7:00pm

Exhibitor 1:00pm – 7:00pm

Sponsor Dismantle:

Thursday, May 24 2:00pm – 8:00pm

Sponsor Meeting Room Installation:

Sunday, May 20 1:00 pm – 6:00pm

Sponsor Meeting Room Dismantle:

Thursday, May 24 6:00pm – 8:00pm

Deadlines at a Glance

All Sponsors: All deadlines listed are 11:59pm PST

NEW! Download deadlines directly to your Calendar via the FNTECH Sponsor Services Portal – click on the “Show Deliverables” tab and select the option to download.

- | | |
|--|---|
| <input type="checkbox"/> Friday, April 6 | Deadline to to confirm Marketplace Mixer participation |
| <input type="checkbox"/> Friday, April 13 | Last day to upload Company logo in both vector <u>and</u> jpeg formats for Summit signage to FNTECH Sponsor Portal (click on the “Media” tab) |
| <input type="checkbox"/> Friday, April 20 | Deadline to request use of the OpenStack logo or watermark in any form (see page 9) |
| <input type="checkbox"/> Wednesday, April 25 | EARLY BIRD pricing deadline for AV, Electrical, Furniture, Labor, Lead Retrieval, Networking |
| <input type="checkbox"/> Wednesday, April 25 | Networking & Electrical booth layout due to kellyg@fntech.com |
| <input type="checkbox"/> Wednesday, April 25 | EAC Form sent to shipping@fntech.com (if applicable) |
| <input type="checkbox"/> Coming Soon | Shipments can be received at the Advance Warehouse |
| <input type="checkbox"/> Friday, May 4 | Catering orders for booths and meeting room due |
| <input type="checkbox"/> Wednesday, May 9 | STANDARD pricing deadline for AV, Electrical, Furniture, Labor, Lead Retrieval, Networking |
| <input type="checkbox"/> Friday, May 11 | FINAL DEADLINE to order Sponsor Services before the Summit |
| <input type="checkbox"/> Friday, May 11 | LAST DAY to register with Sponsor Codes |
| <input type="checkbox"/> Friday, May 11 | Acknowledgement of Inward/Outward Handling Charges form due |
| <input type="checkbox"/> Friday, May 11 | Last day to enter Booth staff names in the Sponsor Services portal |
| <input type="checkbox"/> Coming Soon | Last day shipments can be received at Advance Warehouse |

Sponsorship Level Deadlines at a Glance

Headline Sponsors Only:

- Friday, April 13 DIY Layout/Concept due for Openstack Foundation approval
- Friday, April 13 Side panel request form and artwork
- Friday, April 13 Custom booth back wall artwork file
- Wednesday, April 18 75% of Keynote content/presentation due for OpenStack Foundation review
- Tuesday, May 1 60-second pre-recorded video/commercial
- Tuesday, May 1 Housekeeping slide (16:9 ratio: jpeg, Keynote or PowerPoint format)
- Tuesday, May 1 Keynote final content
- Friday, May 4 100-word paragraph for inclusion in a Summit preview email sent to all registered attendees

Premier Sponsors Only:

- Friday, April 13 DIY Layout/Concept due for Openstack Foundation approval
- Friday, April 13 Side panel request form and artwork
- Friday, April 13 Custom booth back wall artwork file
- Tuesday, May 1 30-second pre-recorded video/commercial (to be played on monitors around the Summit)
- Tuesday, May 1 40-minute Sponsor Session details
- Tuesday, May 1 Housekeeping slide (16:9 ratio: jpeg, Keynote or PowerPoint format)

Spotlight Sponsors:

- Friday, April 13 Side panel request form and artwork
- Friday, April 13 Custom booth back wall artwork file
- Tuesday, May 1 Marketplace Theater details

Add-on Sponsorships:

- Tuesday, May 1 Marketplace Theater details
- Tuesday, May 1 Full-day and Half-day track details

Registering for the Summit

All attendees (including booth staff) must register for the Summit on Eventbrite:

<https://openstacksummit2018vancouver.eventbrite.com>

To Register using your Sponsorship passes

On the Eventbrite registration page, click on “Tickets” and enter your promotional code BEFORE you check out (see image below). If you are using a complimentary code and are asked to enter credit card information, the code was not entered properly.

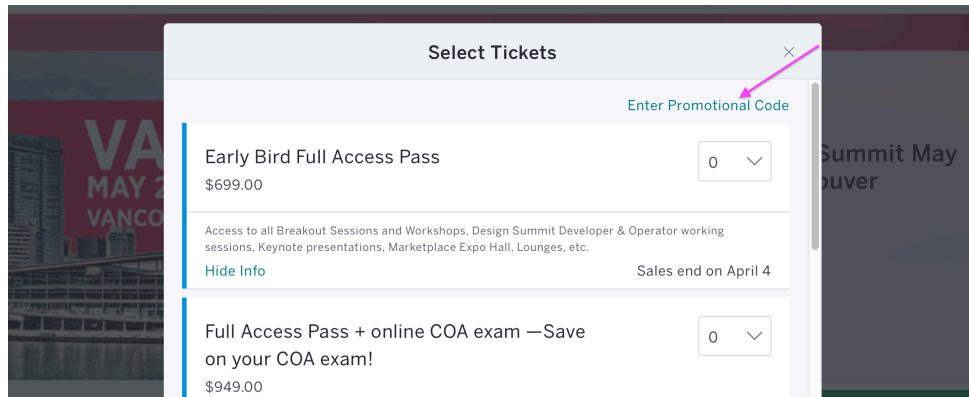

Registering booth staff for the Summit is a 2-step process:

- 1.) Register your staff via Eventbrite: <https://openstacksummit2018vancouver.eventbrite.com>
- 2.) Enter staff names to the FNTECH Sponsor Services Portal, <https://sponsorservices.fntech.com>, under the “Booth Staff Credential” tab

Registration Codes by Sponsorship Level

Headline Sponsor: (15) Full Access, (1) Unlimited 10% discount code, (12) Booth Staff Credentials

Premier Sponsor: (10) Full Access, (1) Unlimited 10% discount code, (8) Booth Staff Credentials

Spotlight Sponsor: (7) Full Access, (6) Booth Staff Credentials

Exhibitor Sponsors: (4) Full Access, (4) Booth Staff Credentials

OpenStack will email registration codes to you. You can also find them on the FNTECH Sponsor Services portal “Registration Code” tab.

Deadline to use Sponsorship Codes in Eventbrite Friday, May 11

Booth Staff Credential FAQ

What is a Booth Staff Credential?

- It is an added designation on the Summit Badge that will grant staff access to the Marketplace outside of normal show hours.

When can I access the Marketplace with the Booth Staff Credential?

- Daily before/after the Marketplace is open to attendees: *8:30am on show days and 30 minutes post Marketplace closing.*
- During Sponsor installation/dismantle hours and during the afternoon setup time before the Marketplace Mixer (*see schedule on page 3*).
- Only staff with a designated Booth Staff Credential and valid Summit Badge will be able to access the Marketplace before and after Summit hours.

NOTE: All Sponsors must wear their Summit badge when they are in the Marketplace outside of normal show hours. For safety and security reasons, Summit Security will ask anyone not wearing a valid Summit badge with the designated Booth Staff Credential to leave the Marketplace immediately.

Who should be assigned Booth Staff Credentials?

- Staff who will set up, dismantle or work first or last shift of your exhibitor booth.
- Staff that are responsible for setting up sponsor meeting rooms and other activities.

Who should NOT be assigned Booth Staff Credentials?

- Any booth staff, employees or executives that do NOT need to enter the Marketplace before/after Summit hours, during installation/dismantle hours or during Marketplace Mixer setup.

Booth Staff Credential DOES NOT:

- Grant anyone access to the Summit, they must also be registered via Eventbrite. See page 6 for the 2-step process to register booth staff.

How many Booth Staff Credentials do I receive?

- See “Registration Codes by Sponsorship Level” on previous page.

What is an Exhibitor Appointed Contractors (EAC)? Do they require a Booth Staff Credential?

- The Exhibitor Appointed Contractors that are hired by you for set-up and dismantle labor do not need a Booth Staff Credential. You must submit the proper paperwork in order for EACs to gain access to the show floor for set-up and dismantle only. Refer to the Shipping Manual for details.

Deadline: Staff names must be entered in the Sponsor Services portal no later than **Friday, May 11.**

Additional Booth staff credentials may be purchased for \$50 each through the Sponsor Services portal.

FNTECH Sponsor Services

The FNTECH Sponsor Services portal is your online resource for:

- Ordering additional services for your presence at the OpenStack Summit
- Accessing sponsor-specific documents
- Uploading marketing deliverables

<https://sponsorservices.fntech.com>

You will receive login credentials for the site via email the week of February 19 or within one week post booth selection. Please contact Kelly Gotelli, kellyg@fntech.com if you do not receive them. If you have used the portal before, the Vancouver Summit will be added to your existing account.

Sponsor Services Order Deadlines:

- Early Bird Pricing Deadline: Wednesday, April 25 at 11:59pm PST
- Standard Pricing Deadline: Wednesday, May 9 at 11:59pm PST
- Sponsor Services Site will be closed: Friday, May 11 at 11:59pm PST

All pre-Summit orders must be received by: Friday, May 11 at 11:59pm PST. Any orders requested after this date will be processed onsite based on availability.

Cancellation Policy:

If the equipment/service order is cancelled by the Sponsor for any reason 21 days or more before the scheduled event (regardless of when the order was placed), a full refund will be issued by FNTECH. If the equipment/service order is cancelled for any reason by the Sponsor within 21 days of the scheduled event, the full balance must be paid to FNTECH immediately with no obligation by FNTECH. Cancellation of any type must be in writing.

Summit Rules & Restrictions

All Sponsors

- **NEW:** Sponsors are not permitted to load-in unless all outstanding balances have been reconciled with the OpenStack Foundation.
- ONLY the official Lanyard Sponsor is permitted to distribute lanyards to Summit attendees.
- Booth staff meetings are not permitted in the Marketplace during set-up hours unless all staff have the proper credentials.
- Projected sound is not permitted in the booths - no microphones/speakers/amplifiers of any sort.
- All signage, furniture and equipment must be kept inside Sponsor allotted booth and contracted space. No exceptions.
- Marketing materials of any kind may only be distributed within your Sponsored contracted space. Distributing flyers in hallways is not permitted.
- Uses of the OpenStack logo or watermark in any form, including booth signage and giveaway items, must be approved via logo@openstack.org. Deadline: Friday, April 20.
- OpenStack Summit Code of Conduct: <https://www.openstack.org/summit/vancouver-2018/code-of-conduct>.

Additional rules and restrictions based on sponsorship level can be found on page 10, 13, 16, and 18.

Headline Sponsor Booth Details

NEW: Headline sponsors now have the option between the traditional turnkey booth or a new DIY booth. Please see details below and on pages 11 & 12.

Headline TURNKEY Sponsors Rules and Restrictions:

- Your booth is turnkey and does not require shipment or setup of a booth property – please see booth renderings on pages 10.
- Custom booth properties, such as demo counters, are permitted, however, counters may not exceed 10ft tall (3m).
- Booth must be open on 3 sides.

Headline DIY Sponsors Rules and Restrictions :

- Backdrops, walls or properties may not exceed 10ft tall (3m).
- Backdrops, walls or properties must fit within booth boundaries (10'D x 25'W x 10'H).
- No rigging above booth- example: Hanging banner.
- Single Story Properties only.
- Booth must be open on 3 sides.
- Default carpet will be provided unless otherwise specified.

Turnkey Headline Sponsor Booth Details

Headline 10'D x 25'W Booth Includes:

- Back wall customized with company logo or custom artwork
- 46" HD monitor with stand
- 6ft black draped table
- (2) chairs
- Black carpet
- Wireless Internet access
- Waste bin
- 15amps of electricity
- (1) power strip

*Power included in package can not be split.
Power will be laid back center of booth unless otherwise specified on booth layout.

10'D x 25'W Booths



Turn key booth - all items included with sponsorship package



Optional side panels shown

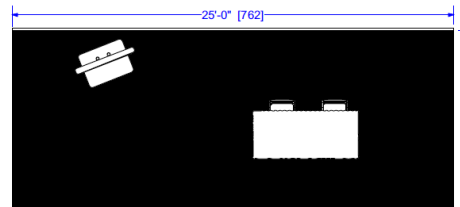

10'D x 25'W (3.1m x 7.6m) Booth

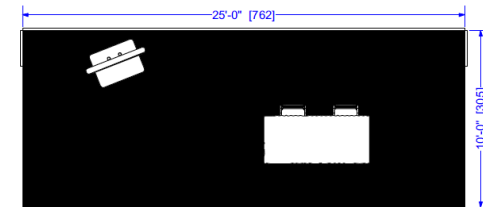

10'D x 25'W (3.1m x 7.6m) Booth w/ 2.5' (.76m) Side Walls

Note:
Chair type and table cloth color are subject to change.

Should you require any additional services, such as audiovisual equipment, power, security, custom signage, or Internet connectivity, please work directly with your Sponsor Manager, Kelly Gotelli. All orders must be placed through the sponsor services portal. Your company will be billed directly.

New DIY Headline Sponsor Booth Details

10'D x 25'W x 10'H Booths

DIY 10'D x 25'W Guidelines:

- Backdrops, walls or properties may not exceed 10ft tall (3m).
- Backdrops, walls or properties must fit within booth boundaries (10'D x 25'W x 10'H).
- No rigging above booth- example: Hanging banner.
- Single Story Properties only.
- Booth must be open on 3 sides.
- Default carpet will be provided unless otherwise specified.

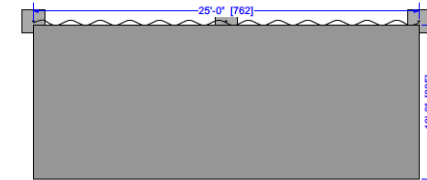
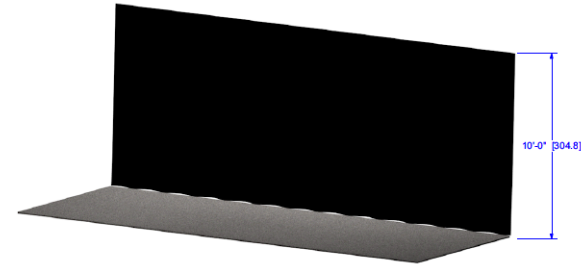

10'D x 25'W (3.1m x 7.6m) Booth

*Carpet color may vary based on final selection from show management.

Deadline: Friday, April 13 Layout/concept is due for Foundation review, please submit directly to Kelly Gotelli, kellyg@fntech.com.

IMPORTANT: Only skilled labor is permitted to construct your booth properties. Please submit your Exhibitor Appointed Contractor (EAC) form and required insurance by deadline or hire labor directly through FNTECH Sponsor Services Portal. This policy will be heavily enforced.

Should you require any additional services, such as audiovisual equipment, power, security, custom signage, or Internet connectivity, please work directly with your Sponsor Manager, Kelly Gotelli. All orders must be placed through the sponsor services portal. Your company will be billed directly.

Premier Sponsor Booth details

NEW: Premier sponsors now have the option between the traditional turnkey booth or a new DIY booth. Please see details below and on pages 14 & 15.

Premier TURNKEY Sponsors Rules and Restrictions:

- Your booth is turnkey and does not require shipment or setup of a booth property – please see booth renderings on pages 14.
- Custom booth properties, such as demo counters, are permitted, however, counters may not exceed 10ft tall (3m).
- Booth must be open on 3 sides.

Premier DIY Sponsors Rules and Restrictions :

- Backdrops, walls or properties may not exceed 10ft tall (3m).
- Backdrops, walls or properties must fit within booth boundaries (10'D x 15'W x 10'H).
- No rigging above booth- example: Hanging banner.
- Single Story Properties only .
- Booth must be open on 3 sides.
- Default carpet will be provided unless otherwise specified.

Turnkey Premier Sponsor Booth Details

Premier 10'D x 15'W Booth Includes:

- Back wall customized with company logo or custom artwork
- 46" HD monitor with stand
- 6ft black draped table
- (2) chairs
- Black carpet
- Wireless Internet access
- Waste bin
- 10amps of electricity
- (1) power strip

*Power included in package can not be split.
Power will be laid back center of booth unless otherwise specified on booth layout.

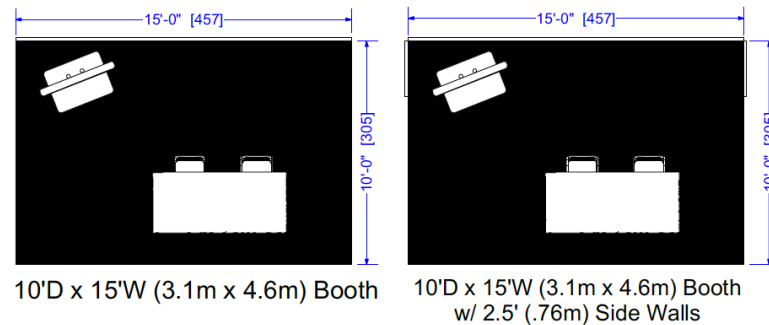
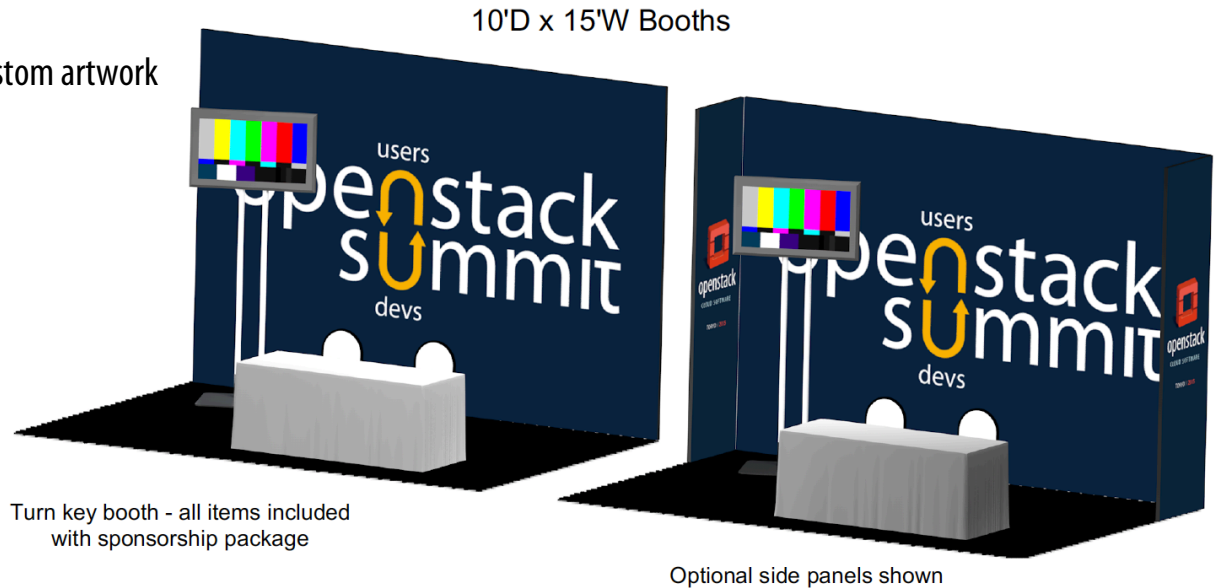

Note:
Chair type and table cloth color are subject to change.

Should you require any additional services, such as audiovisual equipment, power, security, custom signage, or Internet connectivity, please work directly with your Sponsor Manager, Kelly Gotelli. All orders must be placed through the sponsor services portal. Your company will be billed directly.

New DIY Premier Sponsor Booth Details

DIY 10'D x 15'W Guidelines:

- Backdrops, walls or properties may not exceed 10ft tall (3m).
- Backdrops, walls or properties must fit within booth boundaries (10'D x 15'W x 10'H).
- No rigging above booth- example: Hanging banner.
- Single Story Properties only.
- Booth must be open on 3 sides.
- Default carpet will be provided unless otherwise specified.

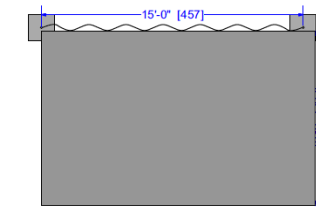
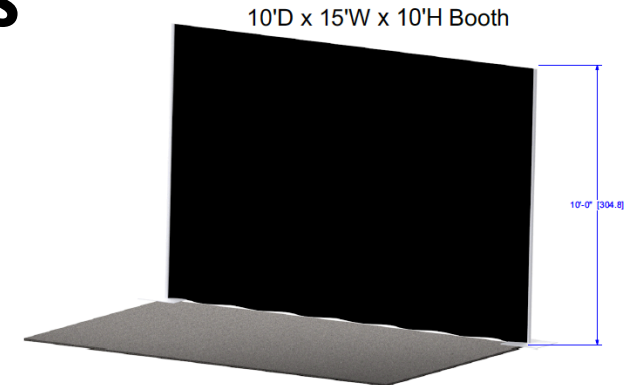

10'D x 15'W (3.1m x 4.6m) Booth

*Carpet color may vary based on final selection from show management.

Deadline: Friday, April 13 Layout/concept is due for Foundation review, please submit directly to Kelly Gotelli, kellyg@fntech.com.

IMPORTANT: Only skilled labor is permitted to construct your booth properties. Please submit your Exhibitor Appointed Contractor (EAC) form and required insurance by deadline or hire labor directly through FNTECH Sponsor Services Portal. This policy will be heavily enforced.

Should you require any additional services, such as audiovisual equipment, power, security, custom signage, or Internet connectivity, please work directly with your Sponsor Manager, Kelly Gotelli. All orders must be placed through the sponsor services portal. Your company will be billed directly.

Spotlight Sponsor Booth Details

Spotlight Sponsor Rules and Restrictions:

- Your booth is turnkey and does not require shipment or setup of a booth property – please see booth renderings on pages 16.
- Removing the back wall is NOT permitted.
- Custom booth properties, such as demo counters, are permitted, however, counters may not be more than 8' tall (2.4m).
- Backdrops, walls or properties must fit within booth boundaries.
- Booth must be open on 3 sides.

NOT PERMITTED:

Demo counters that create a visual barrier.



PERMITTED:

Demo counters that do not create a visual barrier.



Turnkey Spotlight Sponsor Booth Details

10'D x 10'W Booths

Spotlight 10'D x 10' W Booth Includes:

- Back wall customized with company logo or custom artwork
- 46" HD monitor with stand
- 6ft black draped table
- (2) chairs
- Black carpet
- Wireless Internet access
- Waste bin
- 10amps of electricity
- (1) power strip

*Power included in package can not be split.

Power will be laid back center of booth unless otherwise specified on booth layout.



Turn key booth - all items included with sponsorship package

Optional side panels shown

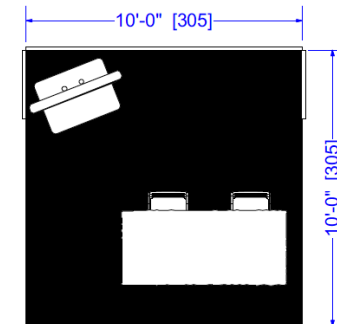
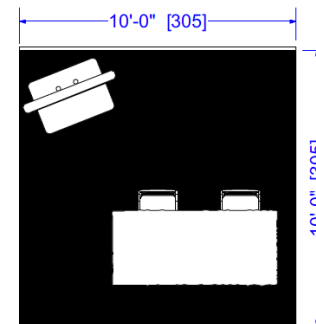

10'D x10'W (3.1m x 3.1m) Booth

10'D x10'W (3.1m x 3.1m) Booth w/ 2.5' (.76m) Side Walls

Note:
Chair type and table cloth color are subject to change.

Should you require any additional services, such as audiovisual equipment, power, security, custom signage, or Internet connectivity, please work directly with your Sponsor Manager, Kelly Gotelli. All orders must be placed through the sponsor services portal. Your company will be billed directly.

Exhibitor Sponsor Table Details:

Exhibitor Sponsor Rules and Restrictions:

- **New:** 4ft counter upgrade now available for an additional charge through the FNTECH Sponsor Services Portal.
- Removing the 6ft table is not permitted unless you have purchased the approved counter upgrade.
- Having both the 6ft table and counter is not permitted. Your space limits you to one table only.
- 8'x8' (2.5m x 2.5m) or 10'x10' (3.1m x 3.1) pop-up booths are not permitted on the show floor.
- Total banner footprint may not be larger than 6.5'W x 8'H (2m x 2.5m).
- Full racks, or other equipment of similar size, are not permitted.

NOT PERMITTED:

Pop-up Booths, Full Racks or equipment equal in size.



PERMITTED:

Pop-up banners or half racks.

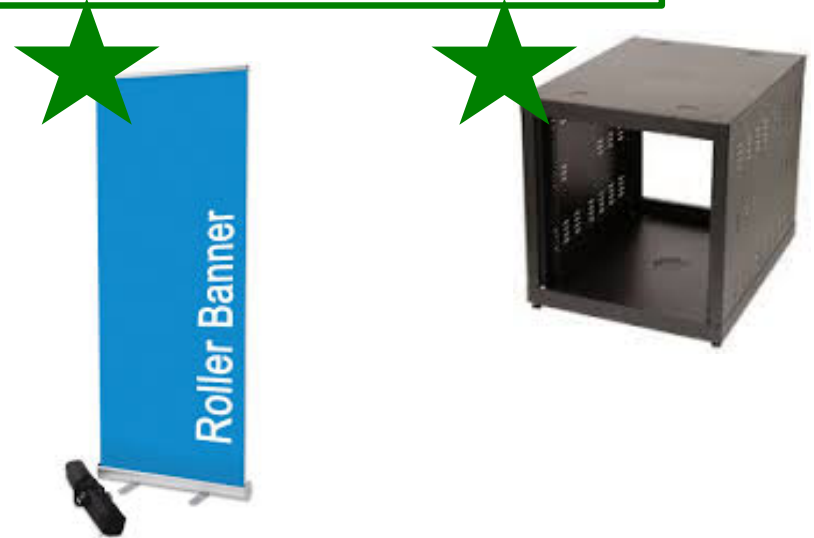

Turnkey Exhibitor Sponsor Table Details

Exhibitor 6' Table Booth Includes:

- 6ft black draped table
- Wireless Internet access
- (1) power strip
- 5amps of electricity
- (2) chairs
- Waste bin

*Power included in package can not be split.
Power will be laid underneath your table unless otherwise specified on booth layout.

Exhibitor Sponsor
Table and Chairs Only

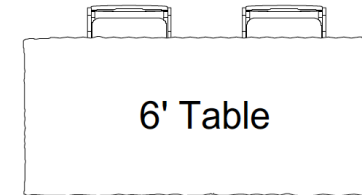
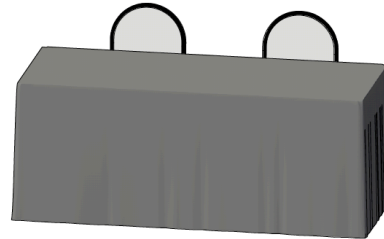

Note:
Chair type and table cloth color are subject to change.

Should you require any additional services, such as audiovisual equipment, power, security, custom signage, or Internet connectivity, please work directly with your Sponsor Manager, Kelly Gotelli. All orders must be placed through the sponsor services portal. Your company will be billed directly.

Booth Renderings

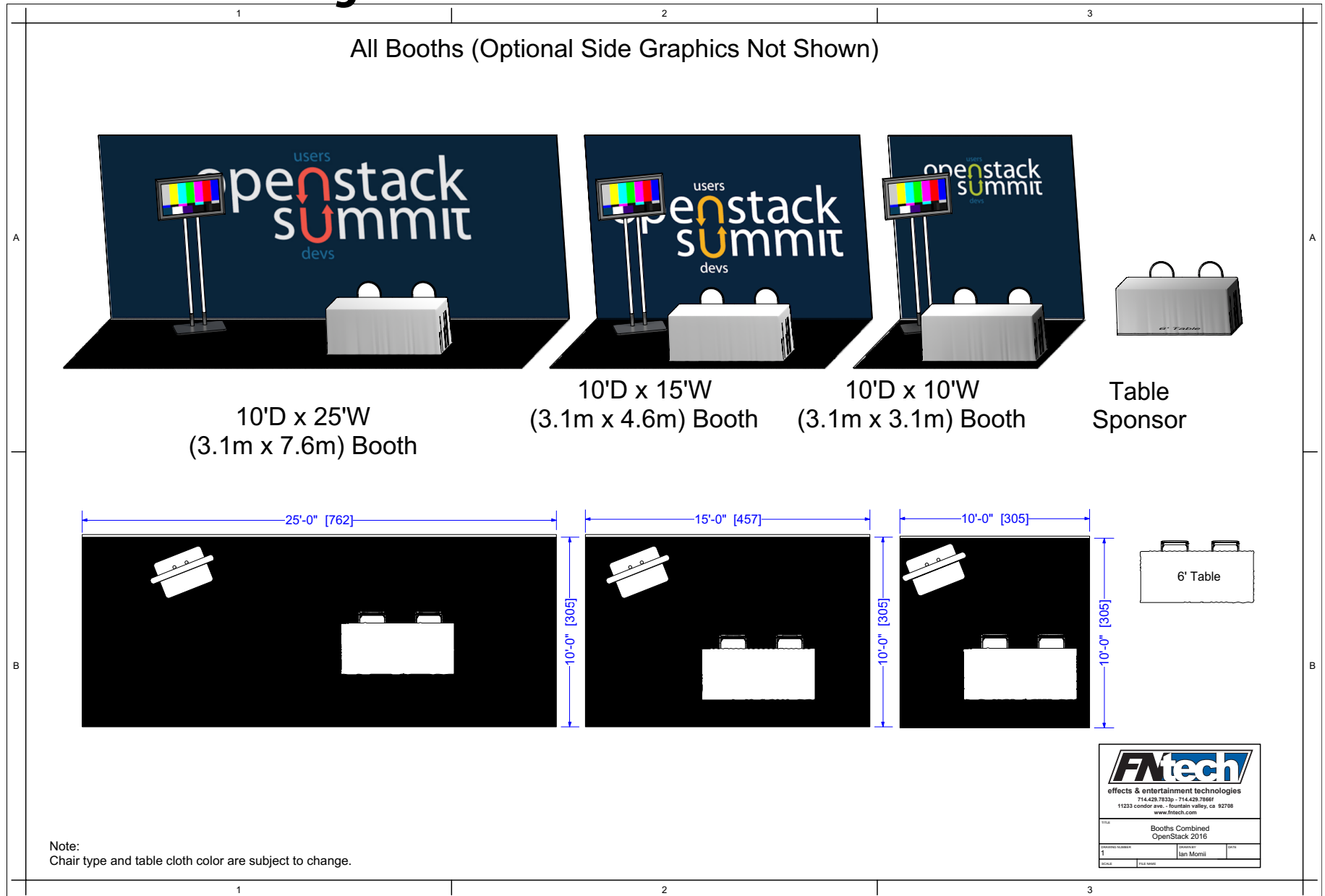

Booth Backdrop Information & Deadlines

Custom artwork for your back wall is due no later than **Friday, April 13**.

- If artwork is not received by **Friday, April 13**, your logo will be printed on the backdrop.
- Upload artwork directly to the “Media Upload” tab of the Sponsor Services portal.
- Additional Fees will be imposed on late, re-submitted or improperly submitted artwork, please read the following CAREFULLY.

File Requirements:

- Finalized artwork should be received in pdf format.
- IMPORTANT NOTE: Do not include a bleed or crop marks (backdrop will be stretched ~.8" on each edge to fit the frame).
- Leave a 2" SAFE trim margin for all text and essential graphics.
- All text (including logos) MUST be converted to outlines.
- Resolution should be minimum 150dpi (at FULL size, see backdrop artwork dimensions on next page).
- Embed all placed images, scans and illustrations.
- Set files to CMYK color space. Change spot colors like HKS or Pantone to CMYK color space.

If Your Artwork Contains Gradients:

- Rasterize vector gradients AND add 4% noise/grain.
- The "lightest" value must be higher than zero (at least a 5% color).
- Use a blend that changes at least 50% between two or more process-color components.
- Make dark blends short. Banding is most likely to occur between very dark colors and white.
- If you create a gradient between two or more spot colors, assign different screen angles to the spot colors when you create color separations.

Please see the following page for information on your backdrop size. Files may be sent at 'HALF' size if it will greatly reduce the file's storage space.

Booth Backdrop Specs

Headline Sponsors

- Specs: 25'w x 10'h (7.61m x 3.1m)
- Printed on a seamless fabric
- Artwork Options:
 - FULL size: 300" x 120"
 - HALF size: 150" x 60"

Premier Sponsors

- Specs: 15'w x 10'h (4.6m x 3.1m)
- Printed on a seamless fabric
- Artwork Options:
 - FULL size: 180" x 120"
 - HALF size: 90" x 60"

Spotlight Sponsors

- Specs: 10'w x 10' h (3.1m x 3.1m)
- printed on a seamless fabric
- Artwork Options:
 - FULL size: 120" x 120"
 - HALF size: 60" x 60"

Premier Plus Sponsors (add-on 5ft)

- Specs: 20'w x 10'h (6.1m x 3.1M)
- Printed on a seamless fabric
- Artwork Options:
 - FULL size: 240" x 120"
 - HALF size: 120" x 60"

Spotlight Plus Sponsors (add-on 5ft)

- Specs: 15'w x 10'h (4.6m x 3.1m)
- Printed on a seamless fabric
- Artwork Options:
 - FULL size: 180" x 120"
 - HALF size: 90" x 60"

Catering in Sponsor Booth

Catering is permitted in Sponsor booths under the following conditions:

- Sponsor must receive OpenStack Foundation approval prior to placing catering order for booth.
- Coffee service or coffee specialty drinks are NOT permitted to be served in sponsor booths.
- Alcohol may be served in Sponsor booth starting with the daily afternoon break.
- Catering must be kept and distributed from within your booth space.
- All food and beverages must be provided by the Convention Centre catering services; no outside food or beverages will be permitted.
- Please make your request with the Summit catering manager, Sarah Krawiecki (sarah@fntech.com), no later than Friday, May 4.
- Once you receive approval, you will be connected with the Vancouver Convention Centre (VCC) catering department. Ordering and invoicing will be direct between Sponsor and the VCC.

Shipping Information

Shipping Manual

Please thoroughly read the Vancouver shipping manual found on the FNTECH Sponsor Services Portal. This manual details shipping instructions, deadlines, required documentation and handling charges.

Acknowledgement of Inward/Outward Handling Charges

Please read, sign and return the Acknowledgement of Handling Charges (found on the portal) to shipping@fntech.com.

Deadline. Friday, May 11

Advance Warehouse

Coming Soon

Direct to Show

By Appointment ONLY. Full and Semi Trailer Loads ONLY.

NO FEDEX or UPS deliveries will be received at the venue.

Please send Direct to Show appointment requests to shipping@fntech.com.

Advance Warehouse Shipping Label: **COMING SOON**

Please note that all packages must arrive with the following label. Please fill in all areas shown in **GREEN** below with requested information. If packages arrive improperly labeled, we cannot guarantee delivery. A 15% service charge will be applied to final invoices of packages that are received without proper documentation or case markings.

Headline Sponsor Keynote Information:

Keynote Details:

- All Content (slides & video) must be shared with the OpenStack Foundation for review. Failure to submit Keynote content could result in disqualification.
- All Keynote speakers agree to attend mandatory on-site rehearsals one day prior to their presentation.
- Sponsors/speakers are responsible for all content.

Keynote Deadlines:

- Notify the Keynote producer Tamara Pennington, tamara@fntech.com, about any demos and/or special requirements. Sponsor may be responsible to pay for additional production costs. Deadline: ASAP but not later than Wednesday, April 18.
- 75% of content and presentation must be sent to OpenStack Foundation for review. Edits may be required. Deadline: Wednesday, April 18.
- All Final Content must be received prior to keynote. Deadline: Tuesday, May 1.

Premier Sponsor 40 minute Breakout:

- 40 minute breakout session details are due Tuesday, May 1.
- Details to be submitted through a form that will be provided in late March.

Spotlight Sponsor Demo Theater Session:

- 20 minute demo theater session details are due Tuesday, May 1.
- Details to be submitted through a form that will be provided in late March.

Marketing Deliverables

Submit ALL Marketing Deliverables below via the FNTECH Sponsor Services Portal under “Media Upload” <https://sponsorservices.fntech.com>

All Sponsors – Please upload ASAP - Due no later than : Friday, April 13

- Logo in jpeg and vector format for OpenStack Summit Vancouver website and signage.
- Company name as you want it to appear on Summit collateral materials.

Headline Sponsors – Deadline : Tuesday, May 1

- 100-word paragraph for inclusion in a Summit preview email sent to all registered attendees.
- 60-second pre-recorded video/commercial that will be played throughout the Summit on various monitors – no audio.

Premier Sponsors – Deadline : Tuesday, May 1

- 30-second pre-recorded video/commercial that will be played throughout the Summit on various monitors – no audio.

Headline, Premier & Add-On Sponsors – Deadline : Tuesday, May 1

- Housekeeping slide to be played in a loop between presentations (16:9 ratio, image may be provided in jpeg format or as a Keynote or PowerPoint slide.)

Marketplace Mixer

All Sponsors:

- All sponsors are encouraged to offer food and beverage items in their booths during the Marketplace Mixer on Monday, May 21 from 6:00pm to 7:30pm.
- Pricing and food/beverage options will be sent at a later date.
- All food/beverages must be ordered through the official venue catering department. Outside vendors are not permitted.
- Deadline to participate: Friday, April 6.
- Please email Sarah Krawiecki, sarah@fntech.com to confirm participation.

Demo Theater Add-on

Add-on Sponsorship: Opportunity to purchase a 20-minute presentation in the Demo Theater (promoted in official Summit agenda)

- Presentation title, speaker name and abstract due by Tuesday, May 1.
- Time slot selection based on time-stamped agreements.
- Theater specs will be sent via email from kellyg@fntech.com.

Full Day/Half Day Tracks

Add-on Sponsorship: Opportunity to purchase either a Full day or Half day track room (promoted in official Summit agenda)

- Presentation title, speaker name and abstract for all track sessions due by Tuesday, May 1.
- Details will be submitted via the custom submission tool which Sponsors will be granted access to in late March.

Meeting Rooms:

Meeting Rooms include:

- Basic Power: 5amps of power
- (1) power strip on table
- Sponsor wireless internet

Headline Sponsors:

- One meeting room is included with your paid sponsorship.
- Meeting room capacities will vary based on location, but maximum capacity should not exceed 20.
- The standard room set up will consist of a boardroom style table and 12 chairs.
- If you require a different layout, please inform Jacki jacki@fntech.com by Monday, April 3. Modifications to room layouts may incur an additional charge.

Add-on Meeting room Sponsorship:

- Meeting rooms are available to purchase on a first come, first served basis. Please contact jacki@fntech.com for more information.
- Meeting room capacities will vary based on location, but maximum capacity should not exceed 20.
- The standard room set up will consist of a boardroom style table and 12 chairs.
- If you require a different layout, please inform Jacki by Monday, April 3. Modifications to room layouts may incur an additional charge.

Sponsor Contacts

General Sponsor Inquiries: Kelly Gotelli, kellyg@fntech.com

Sponsor Services: Kelly Gotelli, kellyg@fntech.com

Shipping: Ian Prothero, shipping@fntech.com

Catering Request: Sarah Krawiecki, sarah@fntech.com

Meeting Space Request: Jacki Krawiecki, jacki@fntech.com

Other Sponsorship Activities: Jacki Krawiecki, jacki@fntech.com

Paid Sponsored Breakout Sessions: Jacki Krawiecki, jacki@fntech.com

Headline Sponsor Keynote: Tamara Pennington, tamara@fntech.com

Group Hotel Reservations: Sarah Krawiecki, sarah@fntech.com

Other Sponsorship Opportunities: summit@openstack.org